



MEDICAL CART
CATALOGUE

Who we are

With over 20 years of experience in the healthcare industry, MediOne combines the power of domestic production with advanced technology to deliver high-quality, reliable, and innovative medical solutions. Since our founding in 2012, we have expanded our vision through TÜBİTAK-supported R&D projects, offering a diverse product range that spans from medical trolleys to sophisticated electrocautery devices. Driven by an expert team and a commitment to global excellence, we do not just provide medical equipment; we build long-term trust through superior technical support and a professional approach that puts domestic innovation at the heart of global healthcare.



*We Produce
for the World*

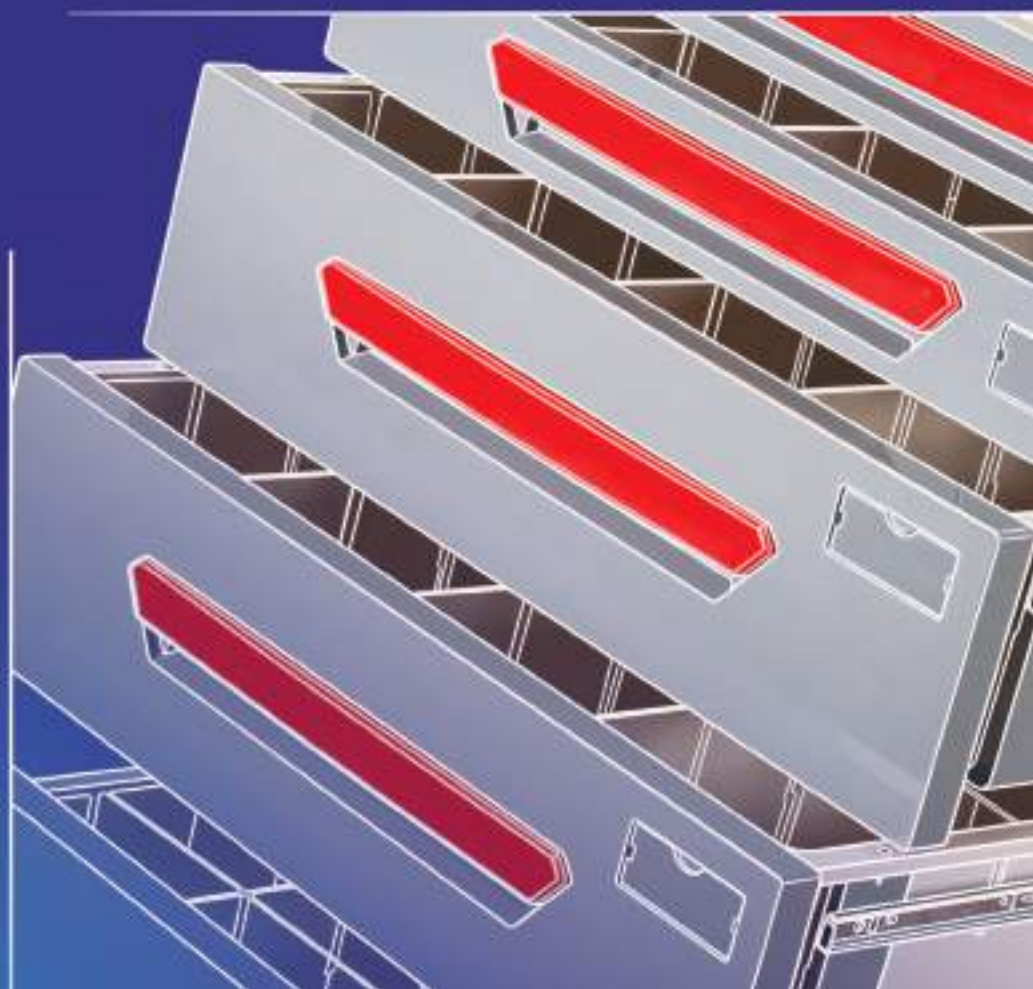



100 kg

Total Load
Capacity

EMERGENCY CARTS



Package Size (cm)

89 x 62,5 x 101

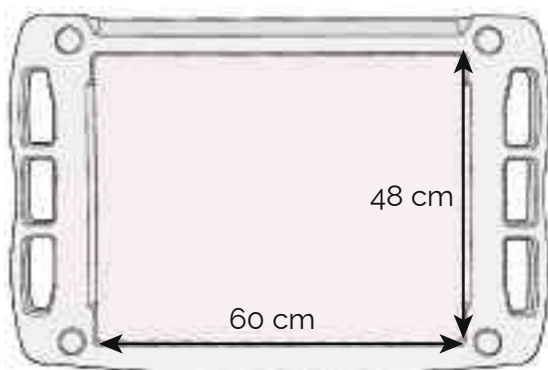
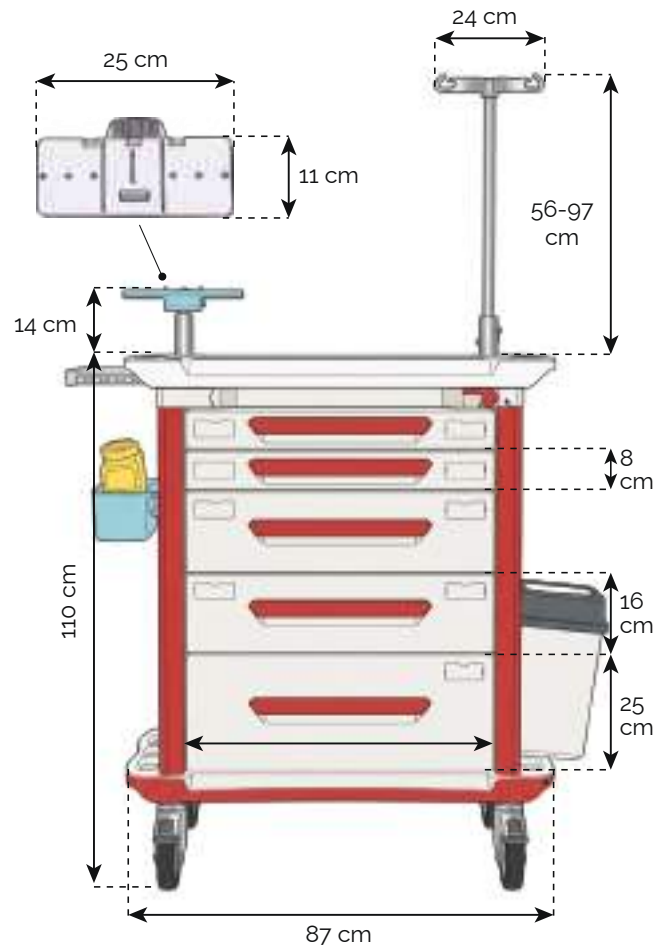
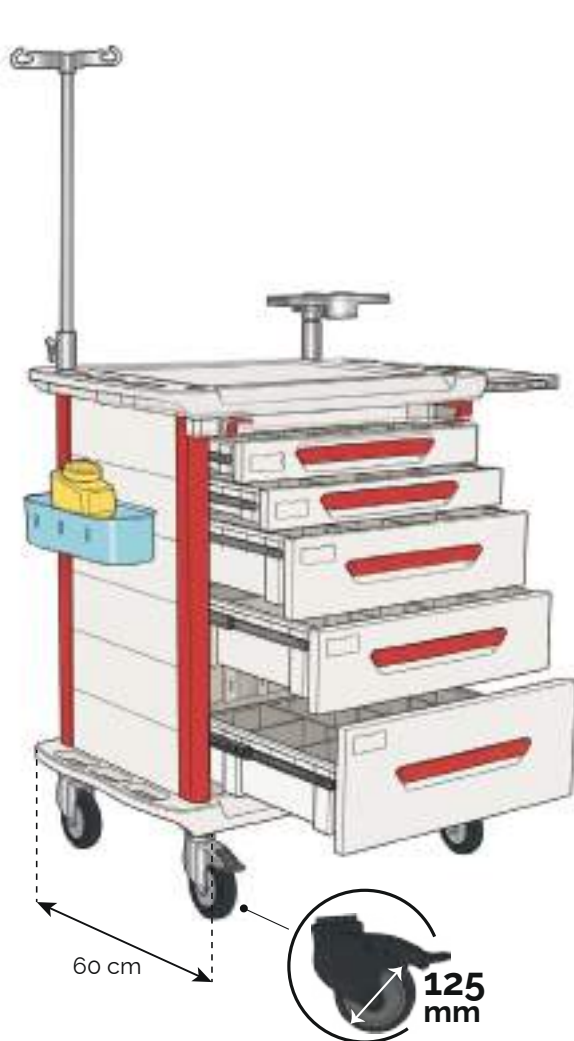

top view

General Features

- Durable ABS plastic body
- Antibacterial surface
- Disinfectant and UV-resistant structure
- Easy-to-clean design
- Ergonomic driving handles
- Foldable medication preparation tray
- Central locking system
- Reusable lock option
- Load capacity over 100 kg
- Different color options
- 2 castors with brakes

Color Options and Codes



MC: Medicine Carts

AC: Anesthesia Carts

EC: Emergency Carts

R: Red

G: Green

B: Blue

W: White



Standard Accessories

- 10 L Waste Bin
- 3-Compartment Supply Basket
- Metal Defibrillator Shelf
- 10 Single-Use Locks
- 5 Drawer Label Holders
- IV Pole with 2 Hooks
- ABS CPR Board
- Oxygen Tank Mounting Kit (Compatible with 1L / 3L / 5L)

Optional Accessories

- Wire Basket
- Catheter Holder
- Double Waste Bin
- ABS Defibrillator Shelf
- Multi-Use Lock
- IV Pole with 4 Hooks
- Electrical Outlet
- Mobile Aspirator Shelf
- Sharps Container (Needle Disposal Box)
- Reusable Lock

Drawer Configuration

- Total of 5 drawers (2 small, 2 medium, 1 large drawer)
- Optional custom drawer arrangement

Drawer Dimensions

- Small: 61 × 48 × 8 cm
- Medium: 61 × 48 × 16 cm
- Large: 61 × 48 × 25 cm

Internal Divider Options

- 1st drawer: 40 compartments
- 2nd drawer: 20 compartments
- 3rd, 4th, and 5th drawers: 12 compartments each



CENTRAL LOCKING SYSTEM

ANESTHESIA CARTS



Package Size (cm)

89 x 62,5 x 101

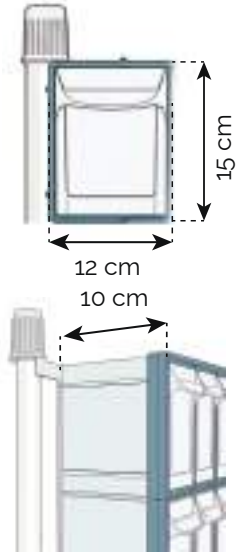
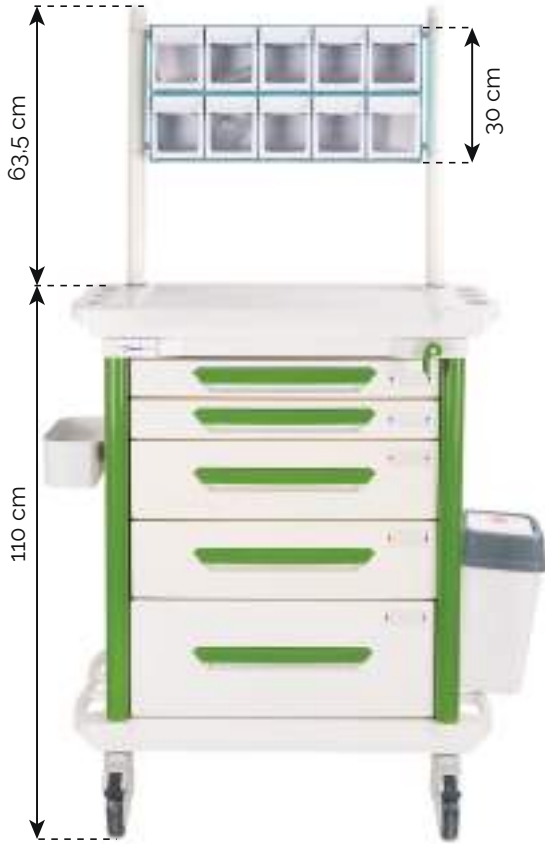

Color Code: **ACGW** (Green) **ACRW** (Red) **ACBW** (Blue) **ACYW** (Orange)

General Features

- Durable ABS plastic body
- Antibacterial surface
- Disinfectant and UV-resistant structure
- Easy-to-clean design
- Ergonomic driving handles
- Foldable medication preparation tray
- Central locking system
- Reusable lock option
- Load capacity over 100 kg
- Red/White and Red/Grey color options
- 2 castors with brakes

Drawer Configuration

- Total of 5 drawers (2 small, 2 medium, 1 large drawer)
- Optional custom drawer arrangement

Drawer Dimensions

- Small: 61 x 48 x 8 cm
- Medium: 61 x 48 x 16 cm
- Large: 61 x 48 x 25 cm

Internal Divider Options

- 1st drawer: 40 compartments
- 2nd drawer: 20 compartments
- 3rd, 4th, and 5th drawers: 12 compartments each

Optional Accessories

- Wire Basket
- Catheter Holder
- 15-Unit Medication Box
- Double Waste Bin
- Multi-Use Locking System
- Triple Electrical Outlet
- Mobile Aspirator Shelf
- Sharps Container (Needle Disposal Box)
- Reusable Lock
- ABS Oxygen Tank Mounting Kit (1L / 3L / 5L)

Standard Accessories

- 10-Unit Medication Box
- 10 L Waste Bin
- 3-Compartment Supply Basket
- 10 Single-Use Locks
- 5 Drawer Label Holders
- 5-Unit Medication Box

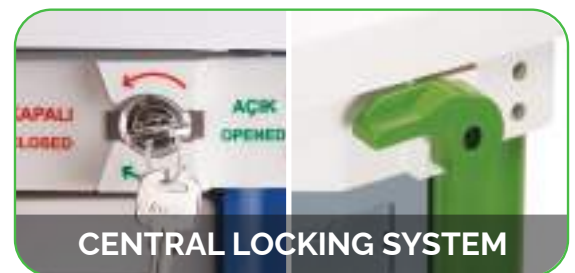

CENTRAL LOCKING SYSTEM



General Features

- Durable ABS plastic body
- Antibacterial surface
- Disinfectant and UV-resistant structure
- Easy-to-clean design
- Ergonomic driving handles
- Load capacity over 100 kg
- Disposable central locking system
- Optional reusable lock
- Different color options

Standard Accessories

- 10 L Waste Bin
- 3-Compartment Supply Basket
- 10 Single-Use Locks
- 5 Drawer Label Holders
- IV Pole with 2 Hooks

Optional Accessories

- Double Waste Bin
- Foldable Med. Prep. Surface
- ABS Defibrillator Shelf
- Wire Basket
- Catheter Holder
- Metal/ABS Defibrillator Shelf
- Multi-Use Locking System
- IV Pole with 4 Hooks
- Triple Electrical Outlet
- Mobile Aspirator Shelf
- Sharps Container (Needle Box)
- ABS Oxygen Tank Mounting Kit (1L / 3L / 5L)

Drawer Configuration

- Total of 5 drawers (2 small, 2 med, 1 large)
- Optional custom arrangement

Drawer Dimensions

- Small: 61 × 48 × 8 cm
- Medium: 61 × 48 × 16 cm
- Large: 61 × 48 × 25 cm

Internal Divider Options

- 1st drawer: 40 compartments
- 2nd drawer: 20 compartments
- 3rd, 4th, and 5th drawers: 12 compartments each

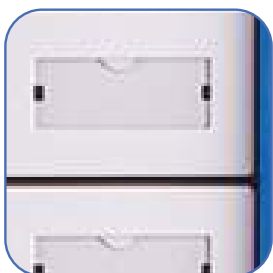

DOUBLE / SINGLE WASTE BIN

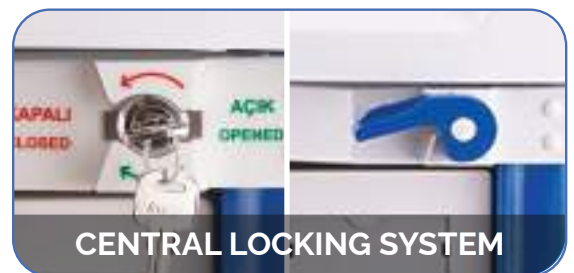

CENTRAL LOCKING SYSTEM





Double Waste Bin



ABS Defi/Monitor Tray



Needle Disposal Box



Electrical Outlet

OPTIONAL



Medical Caster System



Central Lock System



CPR Board



Wire Basket



Medication Boxes



Double IV Pole



Cylinder Holder



Waste Box 10lt.



Defi/Monitor Tray



**Medicine Preparation
Tray**



3-Section Basket

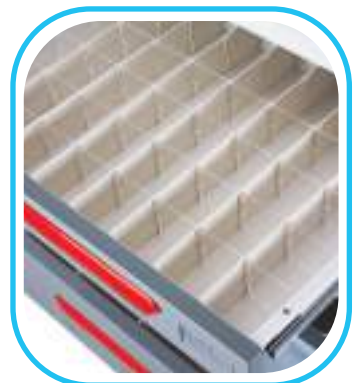

Separators



60 kg
Total Load Capacity





Package Size (cm)

50 x 25 x 77

MEDICAL DEVICE TROLLEYS



P2



P2D



P2DB



P2DBB



P3U



P3GDB



P3WDB

General Features

- Durable ABS plastic body
- ABS top tray and chassis structure
- Easy-to-clean hygienic surface
- Disinfectant/Waterproof Structure
- Ergonomic push handle
- Silent 75 mm castors
- System with 2 braked castors

Optional drawer options

Optional supply basket

Optional IV pole

Optional protective barrier system

Height Options

- 2-Tier: 800 mm
- 3-Tier: 800 mm
- 4-Tier: 1105 mm
- 5-Tier: 1420 mm

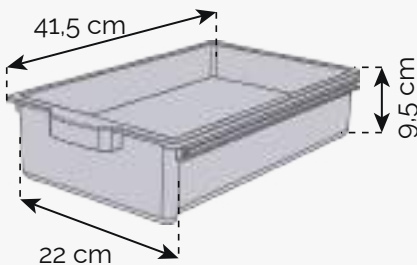
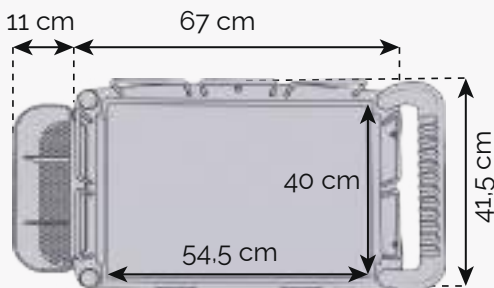

Color Options and Codes



P2DBB

P: Plastic Cart
2: Shelf count
D: Drawer

B: Barrier
B: Basket



MEDICAL DEVICE TROLLEYS



Package Size (cm)

50 x 25 x 77



P4UD



P3D



P5U



P5UD

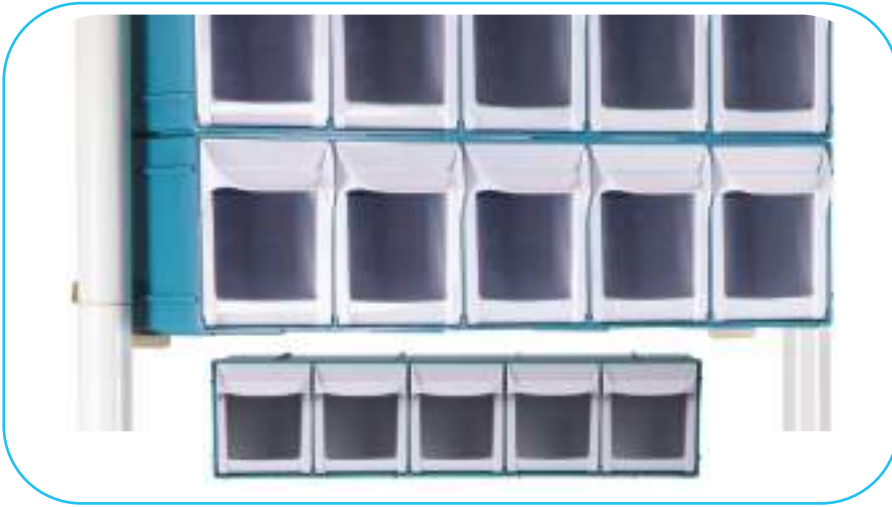

Medicine Box



**75 mm Wheel
(Grey)**



Drawer



**75 mm Wheel
(Smoke Grey)**



Accessory Basket



Waste Box 10 lt.

Locked ABS
Monitor Tray

90° Easy
Montage

Double-Sided
Grab Handle

Fixed ABS
Monitor Tray

8 lt.
ABS Plastic
Basket

Latched Metal
Monitor Tray

Aluminium
Column

ABS-coated
Cast Iron

Aluminium Sliding
Monitor Tray

Medical Casters

50 kg
Total Load
Capacity



Package Size (cm)

92 x 62 x 17,5

TROLLEYS

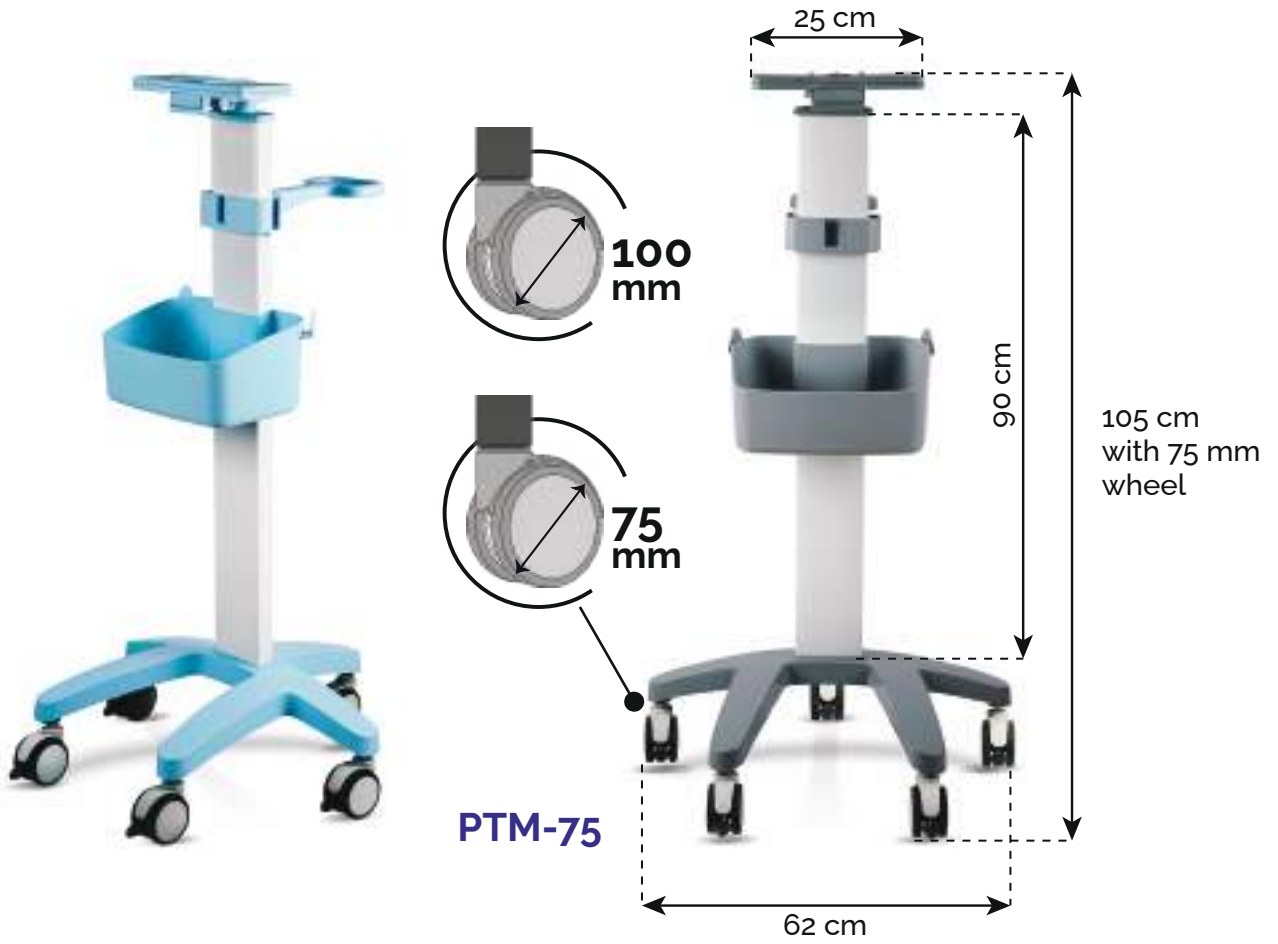

MONITOR TROLLEY



DEVICES TROLLEY

3 Color Variations

TROLLEYS



Package Size (cm)
92 x 62 x 17,5



VENTILATOR
TROLLEY

VT-100



ECG
TROLLEY

ECG-75



3 Color Variations



**5 Castor 100mm Break
Stand / Size: 62x60 cm
Weight: 5 kg**



ECG Cable Holder



**5 Castor 75mm Break
Stand / Size: 62x60 cm
Weight: 5 kg**



**Respirator Safebody for
All Accessory Connection**



**Accessory Basket
ABS Plastic Material**



**4 Castor 75mm Break
Stand / Size: 62x60 cm
Weight: 5 kg**



3-Jointed Circuit Arm

WALLMOUNT KIT



Package Size (cm)
40 x 21,5 x 17,5

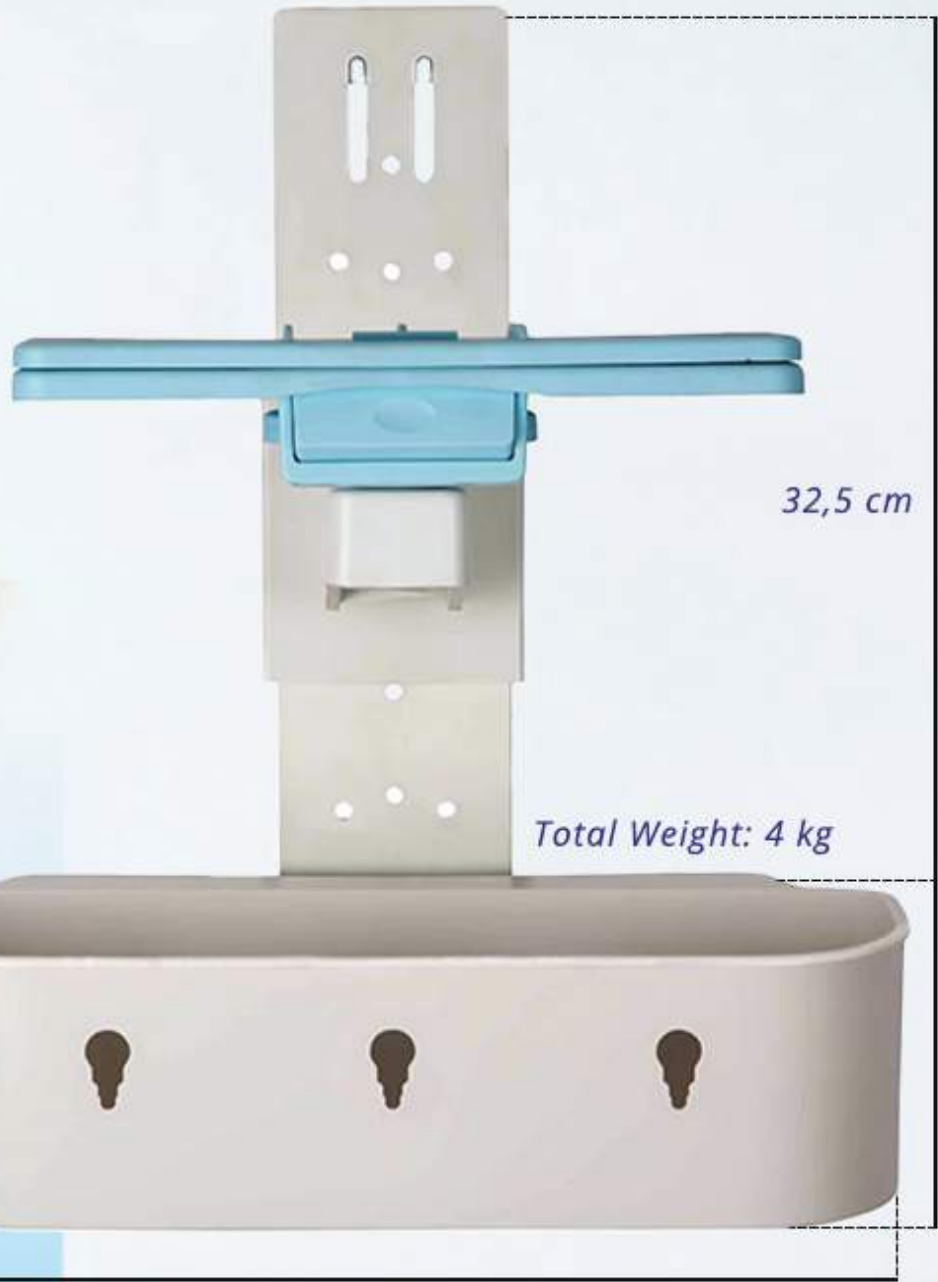

90° 90°



20 kg
Total Load Capacity



*We Produce
for the World*



**AVRASYAMED MEDİKAL TIBBİ CİH.
VE ÜR. PAZ. SAN. VE DIŞ TİC. LTD. ŞTİ.**

Cihangir Mah. Güvercin Cad. No:4 İç Kapı No:144
Avcılar, İstanbul, Türkiye
Tel: +90 212 590 42/41/40
info@medione.com.tr
info@avrsyamed.com.tr

